

Figure 1



This product is suitable for installation in zones: **2** **Qz**

All installations must comply with guidelines which are based on a zonal concept. The diagram above illustrates this concept and must be followed to ensure the safe installation of bathroom ventilation. These regulations apply to domestic installations only. Installations must be made in accordance with the current IEE wiring regulations and relevant building regulations. HiB recommends that all electrical bathroom products should only be fitted by a suitably qualified, Part P registered electrician. This product is suitable for installation in Zone 2 & Outside Zones.

Quality Bathroom Products

Wall Mounted Ventilation Fixing Instructions

Thank you for purchasing this HiB product. Please read through these instructions carefully and refer back to them during installation to ensure that your product is fitted safely and that it retains its high quality finish.

Please retain this leaflet for future reference.

Electrical Safety Information

HiB recommends that all electrical bathroom products should only be fitted by a suitably qualified, Part P registered electrician in accordance with current IEE regulations.

Ensure mains power supply is switched off before starting installation.

Before drilling, ensure there are no hidden cables or pipes in the wall.

Technical Information

Power input: 220-240 V, 50 Hz

Maximum ventilation volume: 97 m³/hr (±5%)

Power consumption: 7.5W

Dimensions: W158 x H158 x D125mm

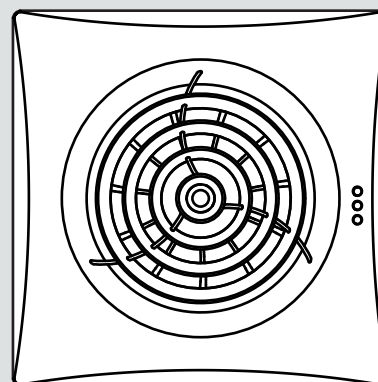

Hush, ultra-quiet wall fan
Art nos. 31500, 31600

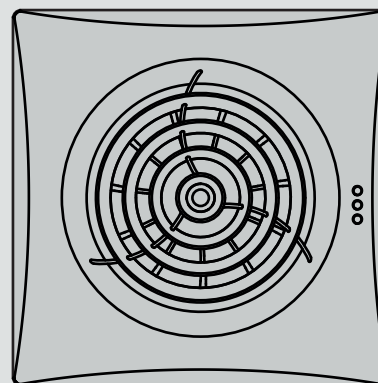

Hush, ultra-quiet wall fan
Art nos. 31700, 31800

Position the Fan into the Wall

- 1) Choose a suitable position for your fan according to Figure 1 on the back page. Use a cable finder to check if there are any buried cables or pipes in the wall. Draw around the outside of the fan to determine its exact location with a pencil. Mark the position of the centre of the fan on the wall.
- 2) Drill a hole to mark the centre point using a 10mm drill bit. You should ensure that this hole is angled slightly downwards. Using the drilled hole as a centre point mark the extractor opening on the outside wall.
- 3) Use a 10mm bit to drill a series of holes at 35mm intervals round the edge of the circle that was previously drawn. Use a 60mm bolster chisel and club hammer to chop out the waste.

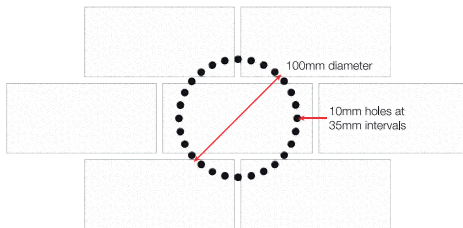

- 4) If necessary, use a chisel and hammer to cut grooves in your internal plasterwork to take the cable and conduit.
- 5) Fit flexible ducting (not supplied) into the hole, flush with both sides of the wall. Ensure the duct slopes slightly downwards towards the outside. Make good any plasterwork

around the duct.

- 6) Position the fan back into place, and mark the four fixing points. Drill the required holes in the marked positions. If drilling through tile, use a ceramic drill bit. Insert wall plugs into the drilled holes.
- 7) Follow a similar procedure for the outside wall grille.

Electrical Connection

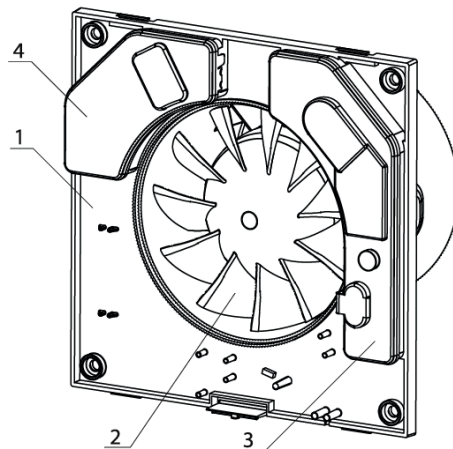

- 1 casing
- 2 fan propeller
- 3 function module
- 4 protective cover of terminal block

- 1) Ensure the domestic electrical mains supply to which the fan is being connected is turned off. This product is designed to be connected to an on/off switch outside the bathroom, or to a ceiling mounted pull cord switch.

- 2) Remove the front panel and protective cover (4). Pass the power wire through the hole in the rubber plug (beneath protective cover) at the fan casing flange.
- 3) Make the electric connections according to the diagram below.

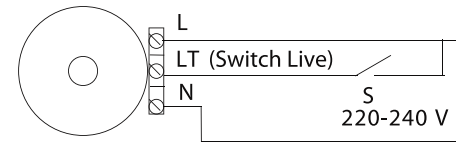

L is brown
LT is brown
N is blue

- 4) Fix the fan to the wall using 4 screws.
- 5) Replace the cover and protective grille.

Operating Instructions

- 1) For Art Nos. 31500 / 31700

Fan with timer option switches on as control voltage is supplied to LT terminal. After voltage is off, the fan continues operating within the set time period T, adjustable between 2 and 30 min. The time is regulated by turning the potentiometer T clockwise to increase and anticlockwise to decrease the running-out time.

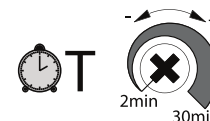

- 2) For Art Nos. 31600 / 31800

Fan with timer and humidity sensor switches on as control voltage is supplied to LT terminal or when humidity level adjustable between 60% and 90% is exceeded. After voltage is off or humidity level H decreases the fan continues operating within the set time period adjustable between 2 and 30 min. Time T and humidity H values are regulated by turning the appropriate potentiometers T and H clockwise to increase and anticlockwise to decrease the running-out time and humidity level respectively. To set the maximum humidity level set the potentiometer in H max (90%) position.

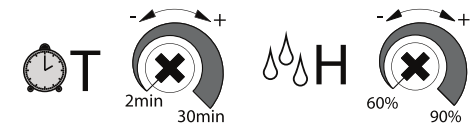

Maintenance

- Fan maintenance is to be performed only after the fan is disconnected from the mains power supply. Maintenance means periodic clearing of the surfaces from dust and dirt.
- All surfaces should be cleaned with diluted detergent, i.e. washing up liquid, and a soft cloth. Scourers and scouring agents should not be used, as these may cause damage to the surface of the product