

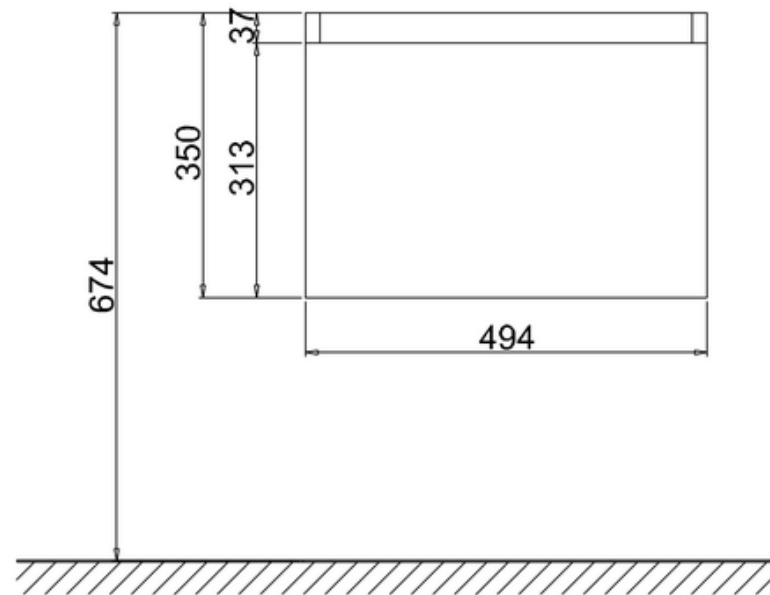

bathstore

41405018300 - MINO 500 DRAWER UNIT NEBRASKA OAK

Note:
th, width, height dimension
tolerance is ± 5 .
r dimension tolerance is ± 2 .

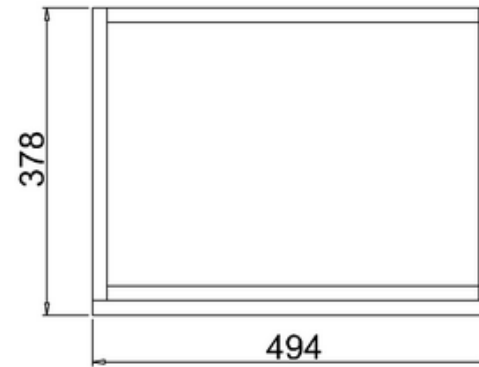
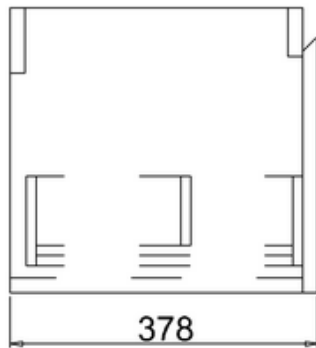



bathstore

41405002640 - ARCHIVE 500 BASIN ONE TAP HOLE WHT BNT-538

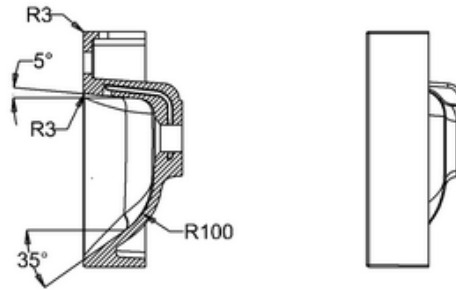
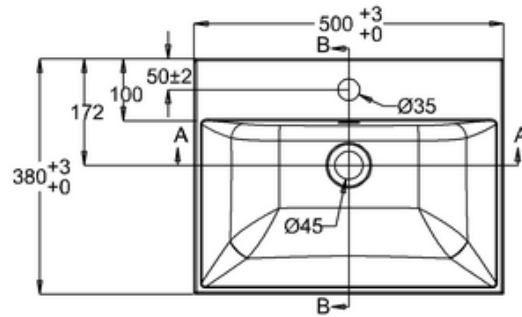

B-B

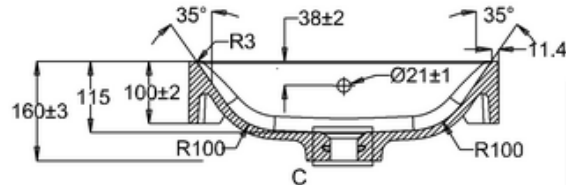

A-A

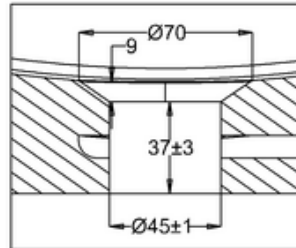

C
SCALE 1:2

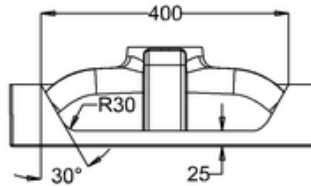
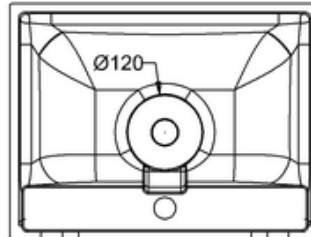

Remark:

- 1: Flatness of installation surface: 0~2mm
- 2: Flatness of whole surface: 0~5mm
- 3: Flatness of main surface: 0~5mm
- 4: Flatness of side surface: 0~4mm
- 5: Distance from tap hole to edge of bowl: Max.80mm
- 6: Dim from basin back to center tap hole: Min.55mm
- 7: Distance between tap hole to drain hole: Max.170mm
- 8: Depth from tap platform to drain hole: Max.250mm

The flatness tolerance should be with in 1.5mm