

LED MIRROR INSTALLATION INSTRUCTIONS

This mirror has a demister pad which is operated by the light switch



Please read these instructions carefully before installation.
Installation should be carried out by a qualified electrician.
Please leave a copy for the user/maintenance engineer for future reference.

GENERAL

- **THIS PRODUCT CONFORMS TO UK SAFETY STANDARDS AND MUST BE INSTALLED IN ACCORDANCE WITH CURRENT IEE WIRING REGULATIONS AND BUILDING REGULATIONS (PART P).**
- **THIS PRODUCT MUST BE EARTHED, AND SHOULD NOT BE CONNECTED TO AN UNEARTHED CIRCUIT. IF THERE ARE ONLY TWO WIRES COMING FROM YOUR POWER SUPPLY IT MEANS THAT THIS FITTING BE WIRED TO AN UNEARTHED CIRCUIT.**
- **ENSURE THAT CONNECTIONS ARE TURNED OFF AT THE CONSUMER UNIT OR FUSE BOARD BEFORE INSTALLING OR CARRYING OUT ANY MAINTENANCE.**
- **THIS PRODUCT IS FOR IN DOOR USE ONLY.**
- **THIS PRODUCT IS IP44 RATED AND CAN BE INSTALLED IN THE ZONE 2 (AS DEFINED BY THE IEE WIRING REGULATIONS) AND BEYOND. SEE THE DIAGRAM BELOW.**
- **REPLACE FAILED LAMPS IMMEDIATELY. ALLOW THE GLASS, LAMP AND FITTING TO COOL BEFORE REPLACING THE LAMP.**

Do NOT strike mirror glass with hard or pointed items. It is recommended that the product is cleaned with a soft, dry, non abrasive cloth. Do NOT use cleaning agents or abrasive materials on any type of finished surface. Do NOT allow moisture to come into contact with the electrical components.

Compliance

This product complies with the following safety standards:
BS EN 60598-1: 2008+A11: 2009, EN60598-2-1: 1989

Wiring

This product is manufactured to class I category and requires an earth connection

COLOUR CODING:

- L - Live = Brown
- N - Neutral = Blue
- ⊕ - Earth = Green & Yellow

Replacing LED strips

WARNING - turn off at consumer unit or fuse board before accessing wiring.
Replace failed LED strips immediately. Allow the glass and light elements to cool before replacing a strip. Replacement LED strips are available from Bathstore. Remove the mirror glass from the body by removing the screws and washers. Disconnect the heated pad by separating the fast connect and place the mirror face down on clean soft surface. Replacement strips should be positioned accurately to ensure full illumination

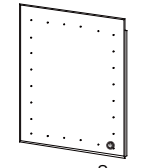

Sensor
41800180560

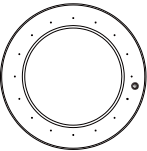

Sensor
41800180570

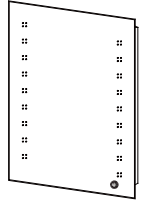

Sensor
41800180580



Sensor
41800180990

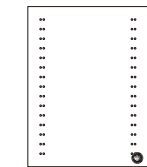

Sensor
41800181000

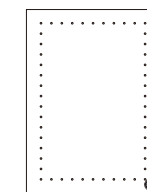

Sensor
41800181040

IEE Bathroom Zones Diagram

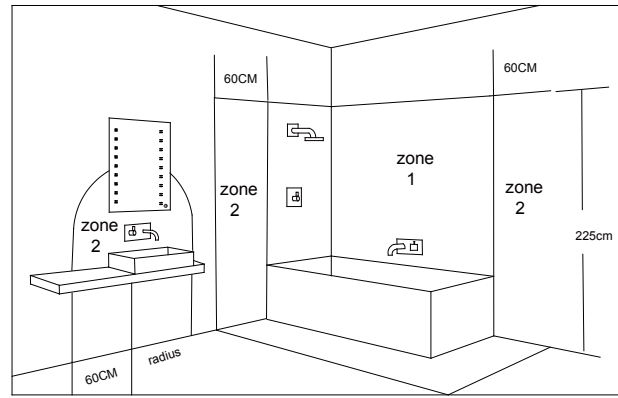

OUTSIDE ZONES

IMPORTANT

- When working at heights, please use a suitable platform to work from.
- **Please note:** For new installations, check for any electrical cables or pipe work (gas/water) in the vicinity of the intended mounting point before proceeding with the installation.
- Ensure that the fixing location is able to take the weight of the complete fitting. Wear suitable eye protection when drilling. Be careful when using power tools near water.

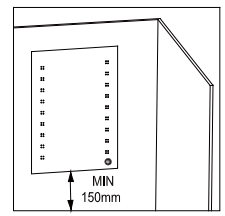

- The product must be installed with a minimum distance of 150mm between the infrared sensor and an adjacent countertop or obstruction to ensure correct function of the sensor(see diagram left)

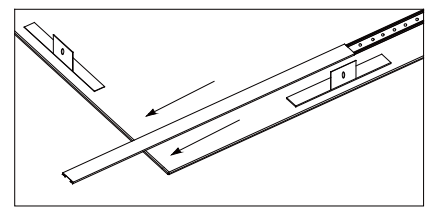

Remove LED

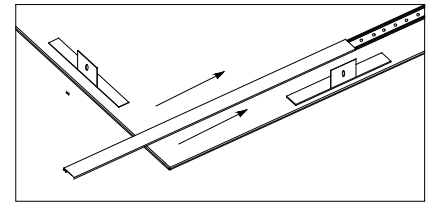

Install LED

LED MIRROR INSTALLATION INSTRUCTIONS

This mirror has a demister pad which is operated by the light switch



Installation procedure

1. Open the carton and make sure all the parts listed below are present

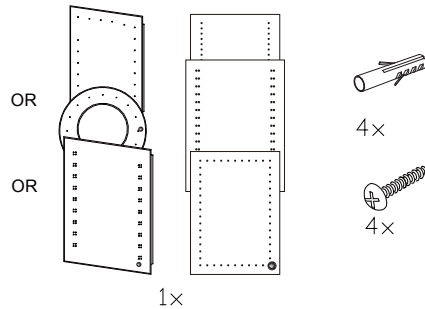

2. Mark a desired height of the mirror. Drill the required holes and insert the wall plugs.
 Note: Wall plugs supplied are only suitable for solid stone/brick walls. Please ensure the screws are fully tight. The rectangular mirrors can be mounted either portrait or landscape. When installing the products, make sure the IR Sensor always locates at proper position. The drain hole at the bottom of the product should be sealed by a blind rubber grommet

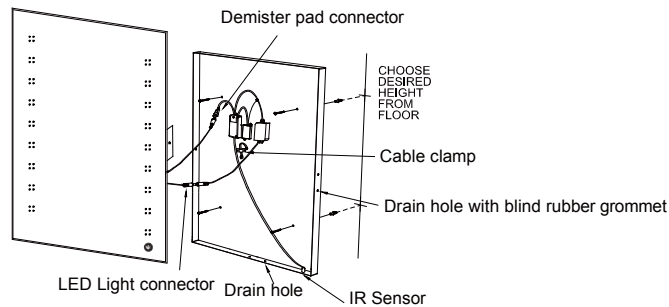

3. Make the electrical connections ensuring first that the electrical supply has been turned off. This mirror is a class 1 product and requires an earth connection. It should be installed in accordance with the latest IEE regulations.

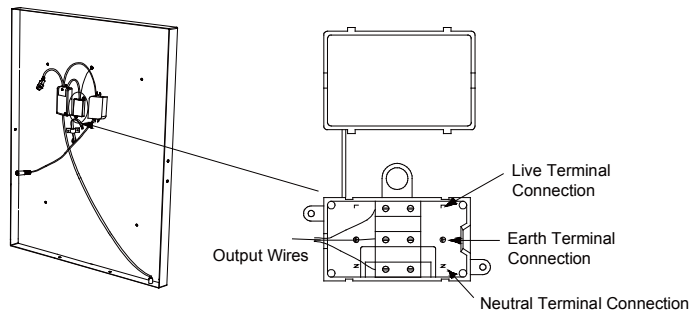

4. Close the connecting box by push down, and secure the cable clamp.

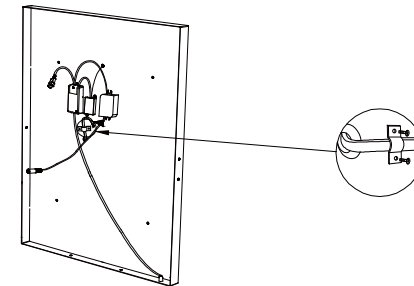

5. Connect the demister pad and secure the mirror.

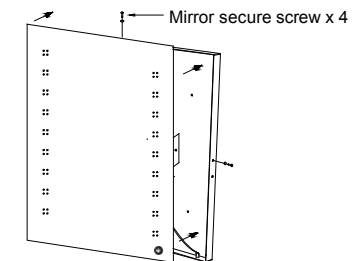

Waste Electrical & Electronic Equipment Regulations (WEEE) requires that any of our products showing this mark (left) must not be disposed of with other household or commercial waste. Bathstore does not levy any WEEE disposal charges to its customers for affected WEEE related products. To prevent possible harm to the environment or human health from uncontrolled waste disposal, please separate any such product from other waste types and recycle it responsibly at your local facilities. Check with your Local Authority, Recycling Center or retailer for recycling advice.

GUARANTEE

This product is guaranteed in the UK for a period of 2 year from the date of purchase. The guarantee is invalid in the case of improper use, installation or tampering. Should this product fail during the guarantee period it will be replaced free of charge, subject to correct installation and return of the faulty unit. Bathstore does not accept responsibility for any installation costs associated with the replacement of this product. Your statutory rights are not affected. Bathstore reserve the right to alter specifications without prior notice.