

# 41405003115 - ShowerCube RIGHT HAND BATH NTH WHT L1600 W850 H425 EXC FEET

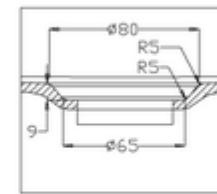

C  
SCALE 1:2

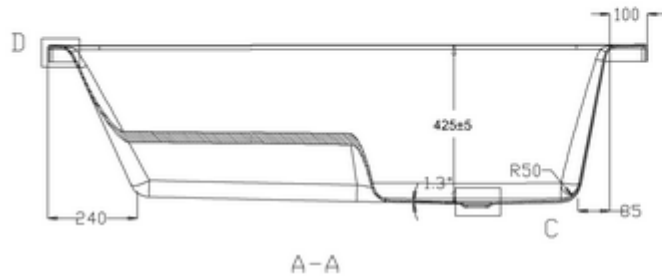
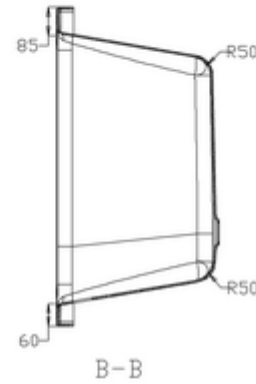
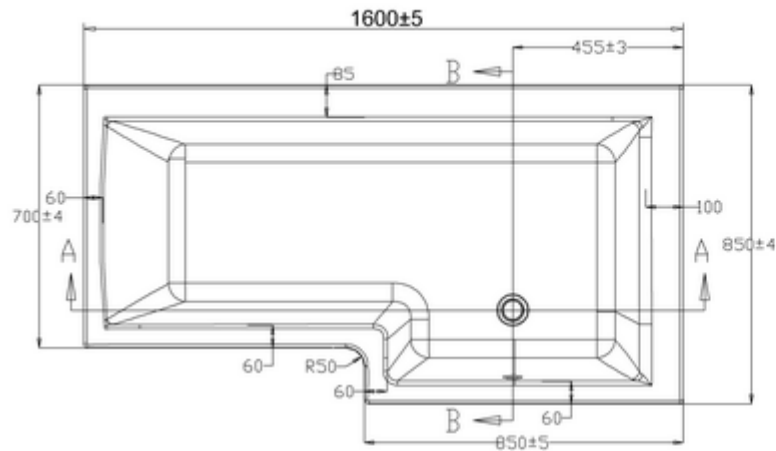
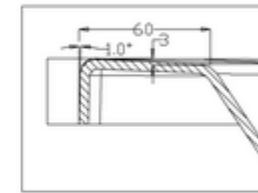

D  
SCALE 1:2

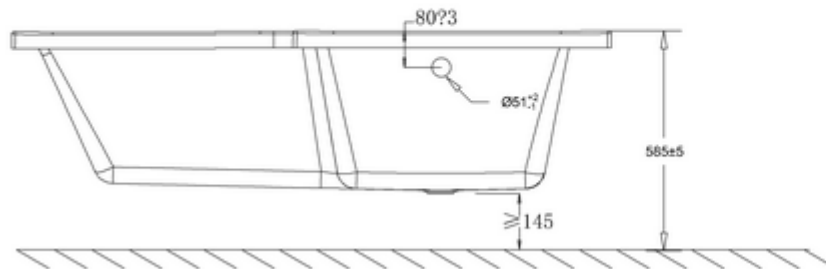
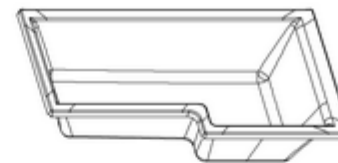

Note:  
 Whole dimension tolerance is  $\pm 5$ .  
 Waste hole dimension tolerance is  $+2/-3$ .  
 Tap hole dimension tolerance is  $+2/-1$ .