

CLOAKROOM BASIN - WALL HUNG INSTALLATION INSTRUCTION

Read instruction carefully before installation

Figure 1:

Determine location for installation of the basin, and mark a line for what would be the actual final height of basin for use once installed. Measure down 90mm from this line, and mark a line for the installation of basin brackets.

- The bracket installation line must be horizontal and level.

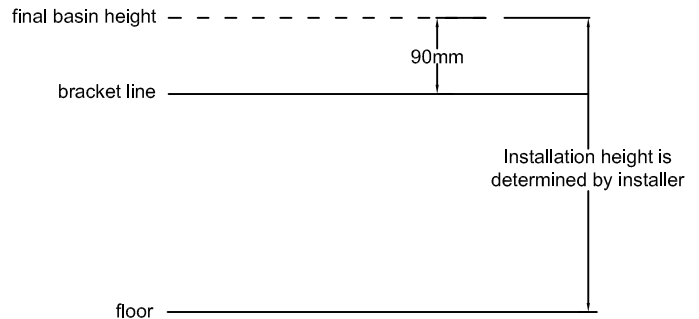

Figure 1

Figure 2:

Basin brackets should be separated by a distance of 315mm. Mark vertical lines at these points, then position the bracket onto the wall as shown in the diagram, and then based on the bracket position mark the installation holes. Fix brackets to the wall using appropriate tools, and fixing bolts for installation surface.

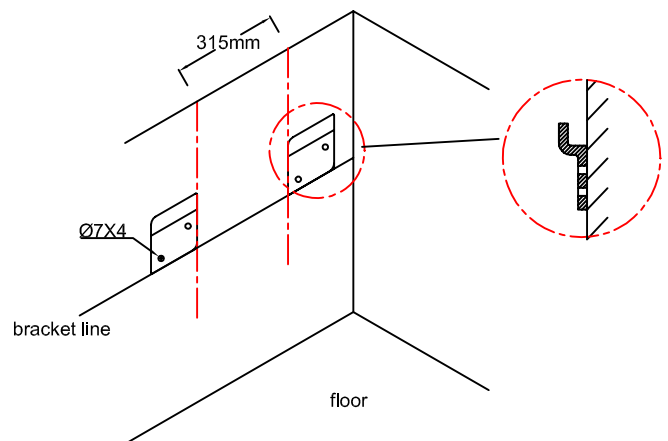

Figure 2

Figure 3:

After the installation of the brackets, hang the basin into position, and check that the basin fits well.

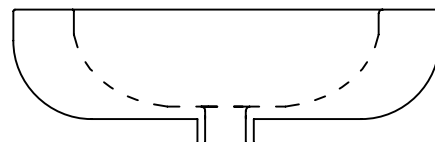

Figure 3

- Installation should be completed by a suitable qualified person.
- Tools and fixing bolts for installation are not supplied, and should be selected by installer based on installation surface.