

Smartline 700, 760, 800 PIVOT DOOR CHR Installation Instructions

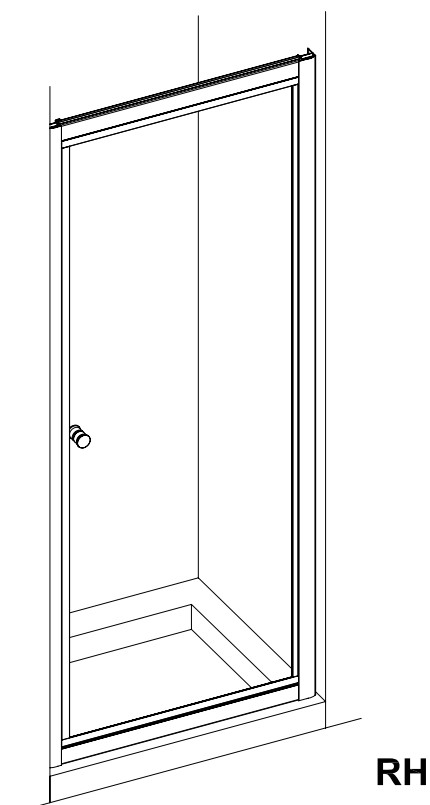

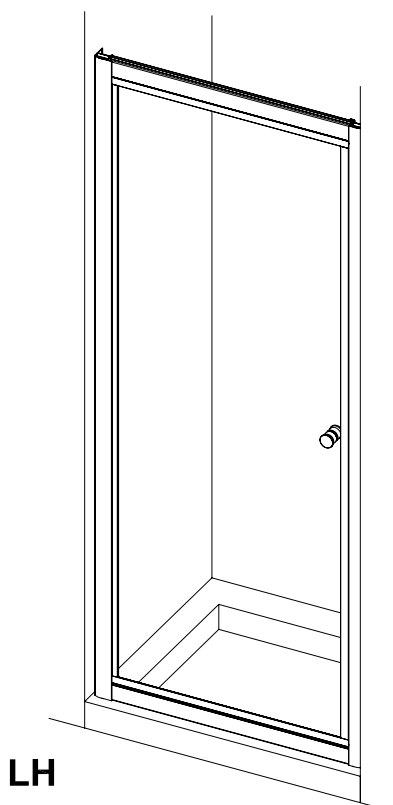

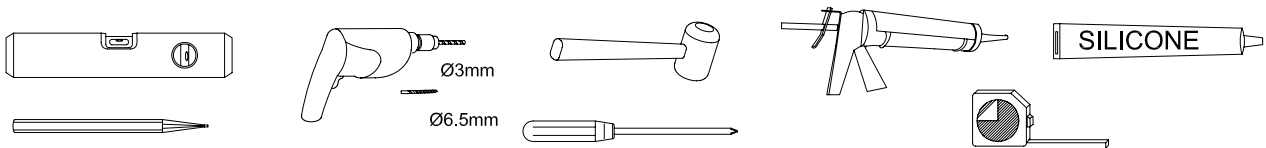

(41300014760, 41300014770, 41300014780)

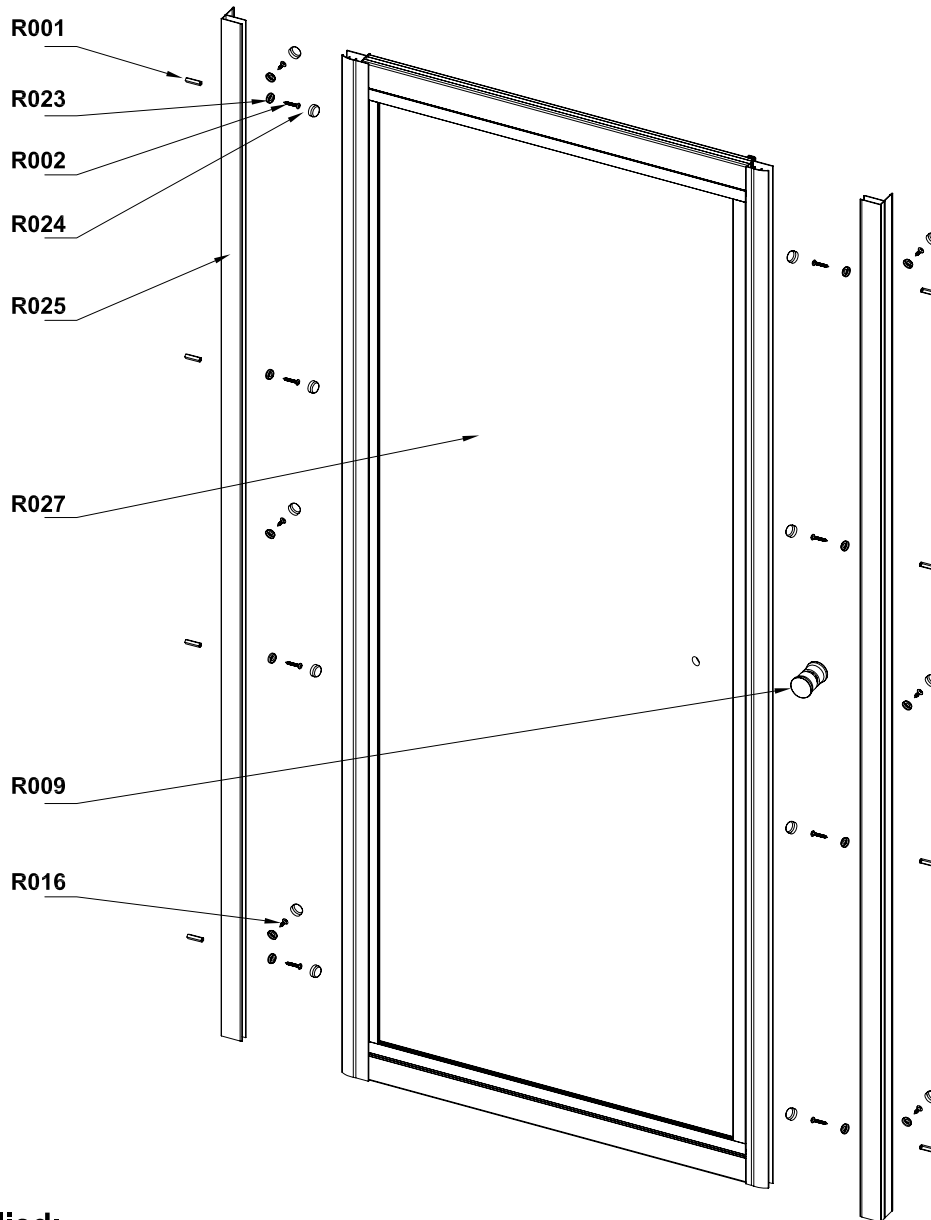
- Prior to installation check that all fittings have been supplied.
- The tray should be installed by a competent person. The tray should be level, the walls should be tiled down to the tray, and the horizontal joint between the tiles and tray must be sealed with silicone sealant to ensure water-tightness.
- Handle with care. Impacts can damage both the glass and the frame.
- Please check for any hidden pipes or cables before drilling holes in the wall.
- The success of the installation and operation is, of course, dependant on the squareness, alignment and construction of the walls to which the enclosure is fixed. If the walls are significantly out of true we recommend dry lining the walls to ensure they are both vertical and at 90 ° to each other.
- The enclosure is reversible: " door can be either left or right opening. "
In the remainder of this manual the illustrations will only show the left hand installation of the pivot door.
- The wall fixings supplied may not be suitable for your installation. You may need to source alternatives depending on the construction of the wall you are fixing to.

Tools Required:



Parts Supplied:

R001	 Wall plug	8x	R024	 Screw cap	14x	R009	 Handle	1x
R023	 Washer	14x	R025	 Wall profile	2x	R016	 M4*12 B head screw	6x
R002	 M4*30 B head screw	8x	R027	Moving door	1x			

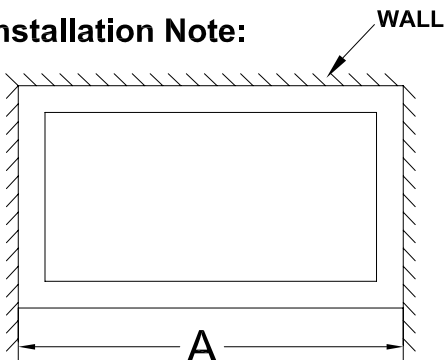
Installation Note:

ADJUSTMENT RANGE	
PRODUCT	A (mm)
700 Pivot Door	655~695
760 Pivot Door	715~755
800 Pivot Door	755~795

Please measure the distance between two walls before installation. Ensure the distance is within the adjustment range of product, as is listed left.

