

Savoy Basin Units Assembly Instructions

IMPORTANT: This unit must be securely fixed to a wall. Ensure that the top is horizontal before marking the wall for fixing.

The wall fixings supplied may not be suitable for your installation. You may need to source alternatives depending on the material and strength of the wall you are fixing to.

Care and Maintenance : Please leave with the householder

This furniture is made of wood, and has a water resistant finish. It should not be left wet, and the quality of the finish is best maintained if it is wiped with a dry cloth after use. It should only be cleaned using a soft damp cloth followed by a dry cloth. Do not use bleach or any abrasive cleaner.

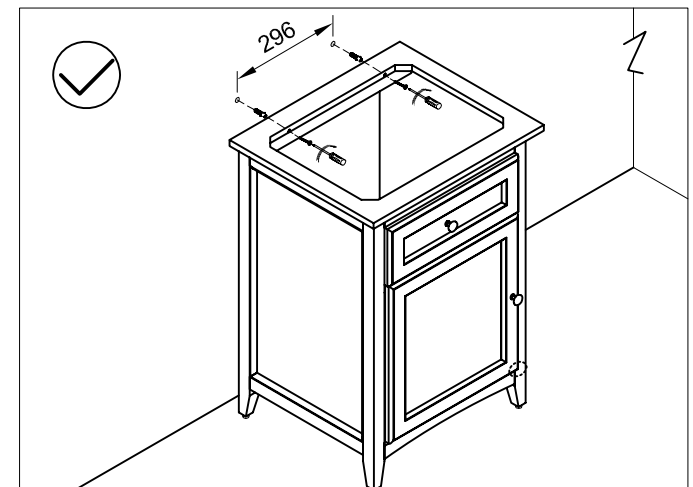
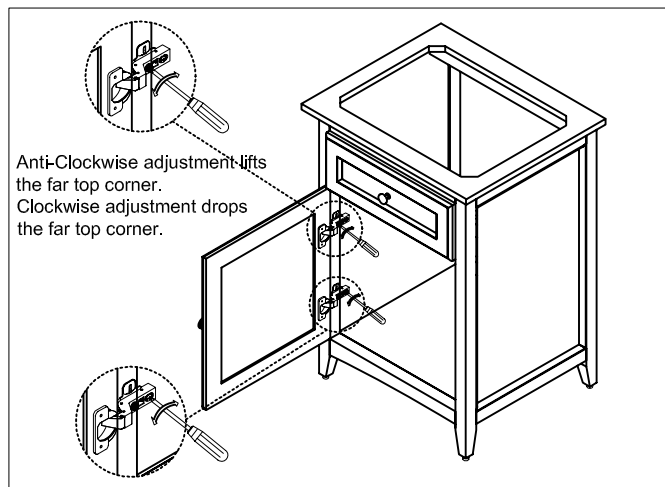
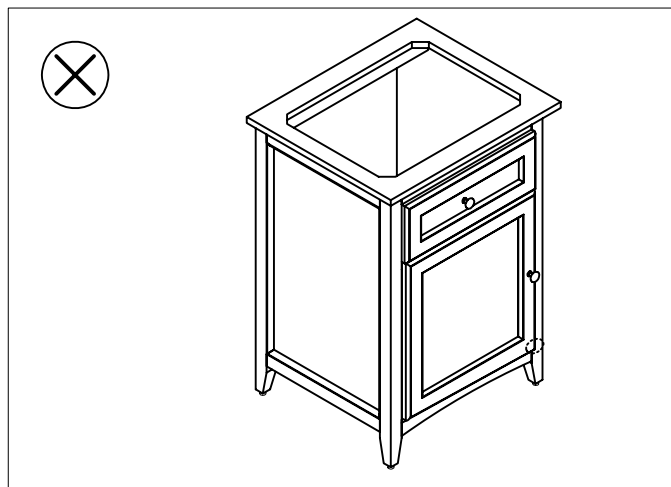
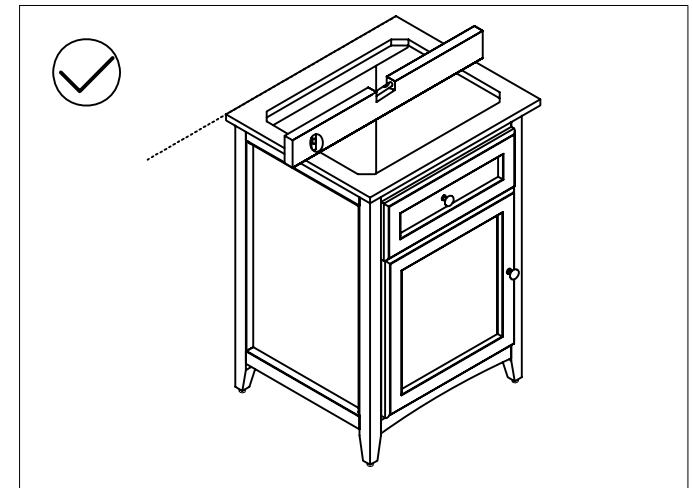
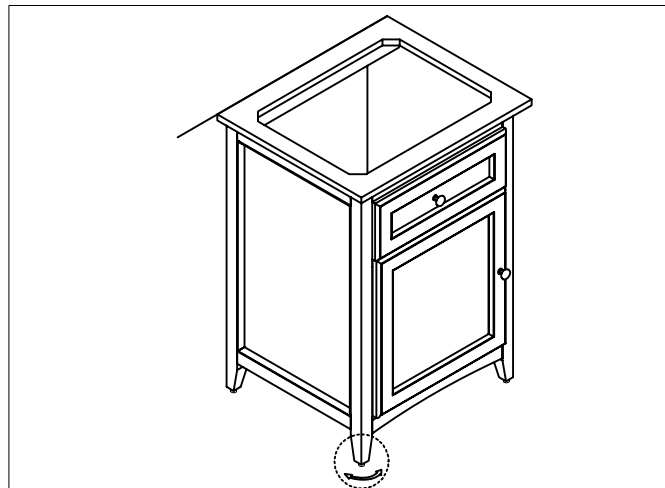
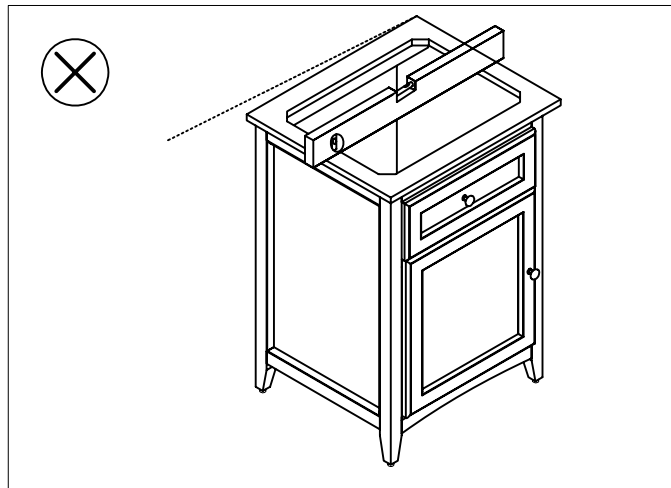

Savoy 600 Carrara Marble / Black Granite 1 Tap Hole Top & Under Counter Ceramic Basin Assembly Instructions For (41800070420, 41800070430)

Parts supplied:

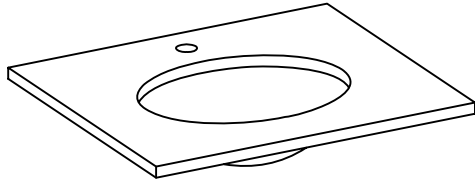

Tools Required:

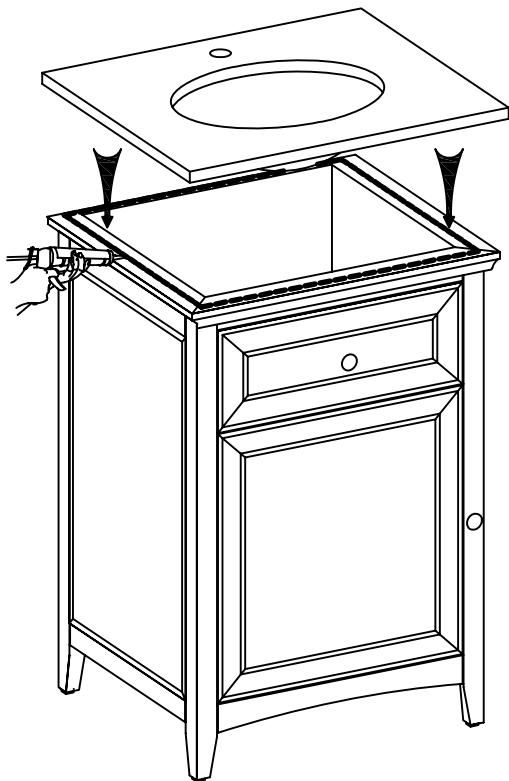
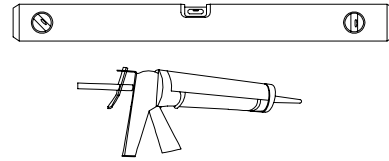

Make sure that the cabinet is level.
Apply silicone seal around the top of the cabinet.
Position the marble or granite top on the cabinet

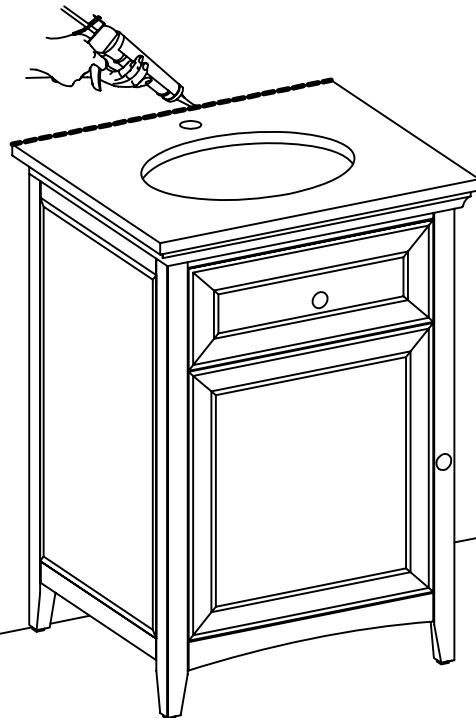

Cleaning

Please leave with the householder

Never use a scourer or other abrasive cleaning agents as this will damage the stone and remove the sealant used to waterproof the marble. This will lead to scratching of the polished surface, and to staining, leaving the surface dull and marked.

Do not use the following on your stone bowl:

- acidic cleaners inc. bathroom, tile or floor cleaners
- ammonia
- powdered or liquid abrasive cleaners
- soft paste cleaners
- vinegar
- alcohol
- window cleaners
- abrasive cleaning pads
- lemon
- steel wool
- or any other material likely to scratch or mark the stone surface.

Maintenance

Stone needs special care. Protect your stone bowl with a professional stone sealer every three years or as recommended. These are readily available from reputable stone care merchants or on-line. We recommend Lithofin Stain Stop (www.Lithofin.com).

BASIN WASTE FLIP TOP SLOTTED CHROME

20003000018

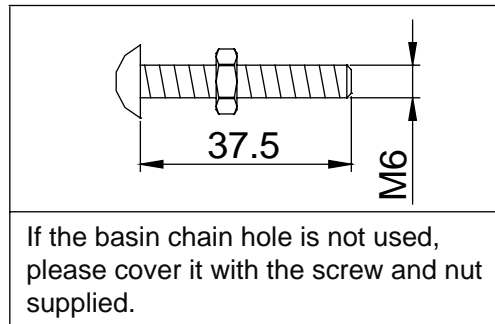
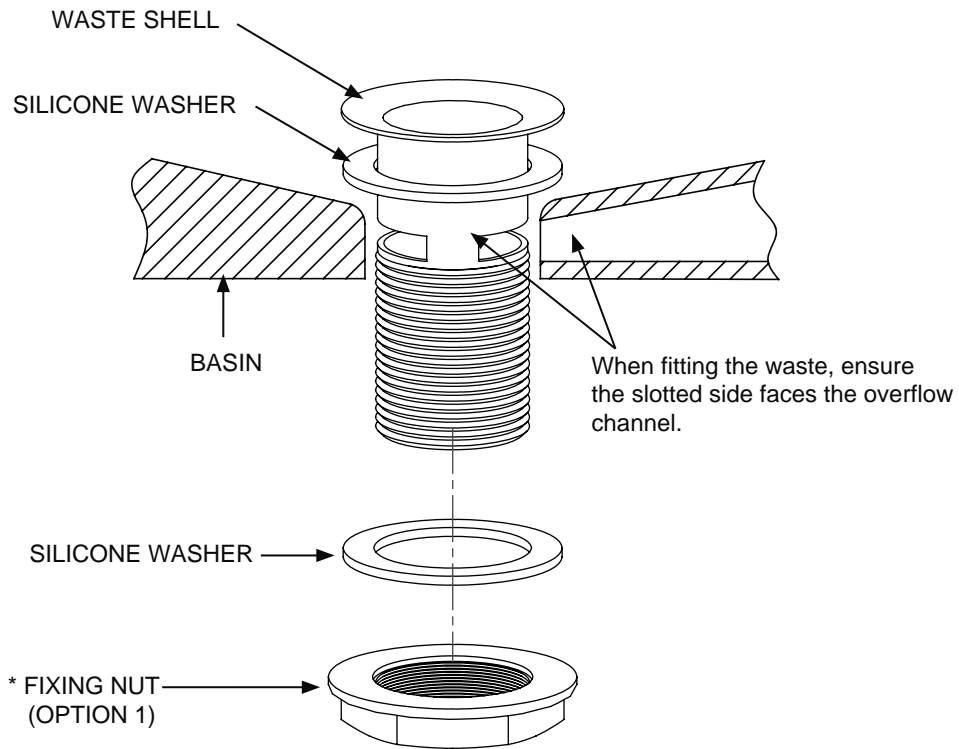

Maintenance

We do NOT recommend you use any household cleaners to clean the product. The product should only be cleaned with soapy water, rinsed with clean water, and dried with a soft cloth.

INSTALLATION INSTRUCTIONS



For any further information please contact Bathstore on: **0845 873 8843**

Or visit our web-site at www.bathstore.com
The manufacturer reserves the right to make technical modifications without prior notice.